

HDMI Industrial Camera User Manual

HY-1139 Industrial Camera V1.5 (English Version)



Description:

- 1: Image sensor: 34 megapixel CMOS Panasonic sensor
- 2: Adopt the 1/2.33 inch image sensor, the viewing angle is more broaden than 1/3 inch
- 3: HDMI output: 1080P 60fps
- 4: USB output: 1080P 30fps
- 5: Support one-key freeze/unfreeze
- 6: 21MP capture and 1080P video recording
- 7: Photo Resolution: 6800x5100
- 7: Support 2.7K 30fps video recording
- 8: Support digital zoom in and zoom out
- 9: Support manual and auto exposure, support EV (exposure compensation) adjust
- 10: Support manual and auto white balance, there are red, green and blue can be adjusted.
- 11: Provide 10 lines, 5 horizontal line , 5 vertical line, any positions
- 12: Support cross hair on/off
- 13: Support TF card storage, max up to 128GB
- 14: Support remote control, it can help you to capture a more clear image
- 15: Support English and Chinese menu (the default language is English)
- 16: Support to save the setting default after power off

Feature:

- 1: Image sensor: 34 megapixel CMOS Panasonic sensor 1/2.33 inch
- 2: Pixel size: 1.335 μ m \times 1.335 μ m
- 3: HDMI output: 1920*1080 60fps
- 4: USB output: 1920*1080/30 1280*720/30 640*480/30 320*240/30 (MJPG)
- 5: Lens interface: C/CS
- 6: Exposure: auto/manual
- 7: EV (exposure compensation): support
- 8: White balance: auto/manual, support RGB adjustment
- 9: Storage: TF card storage, max up to 128GB
- 10: Input voltage: DC 12V
- 11: Line: 10 lines, 5 horizontal line , 5 vertical line, any positions
- 13: Menu language: English/Chinese/Japanese/French/German/ Spanish
- 14: Remote control: support
- 15: Net weight:250g





Package include:

- HY-1139 camera x 1;
- Power supply x 1
- Remote x 1
- USB line x 1
- User manual x 1

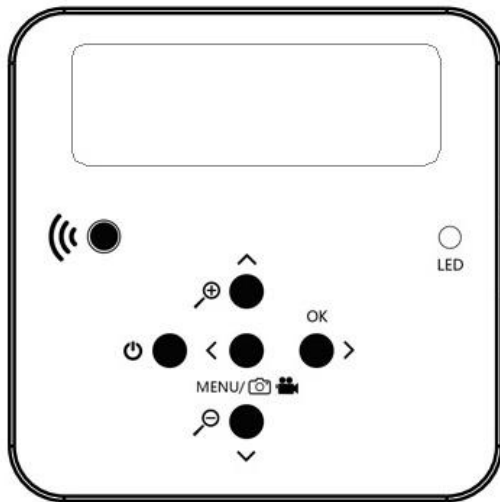
Description of the interface:

- 1: HDMI output interface
- 2: USB output interface
- 3: TF card storage interface
- 4: DC interface (noting: must be 12V)

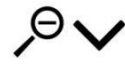

-  Zoom+/Up
-  OK/Right
-  Menu/photo/video
(long press 2 seconds can switch photo and video Mode)
-  zoom-/down
-  Power off/no

SIZE:

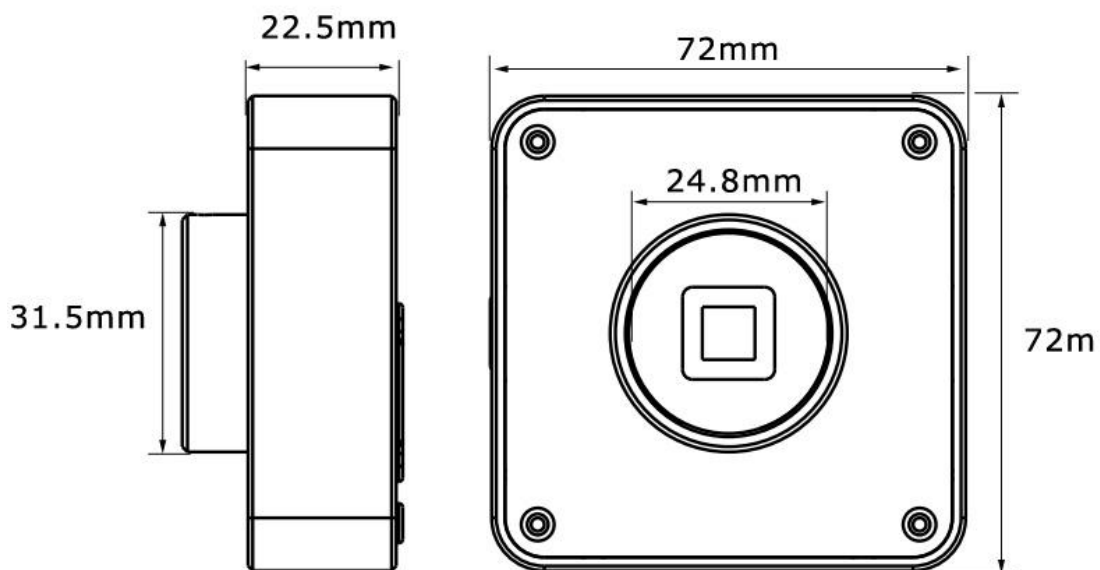

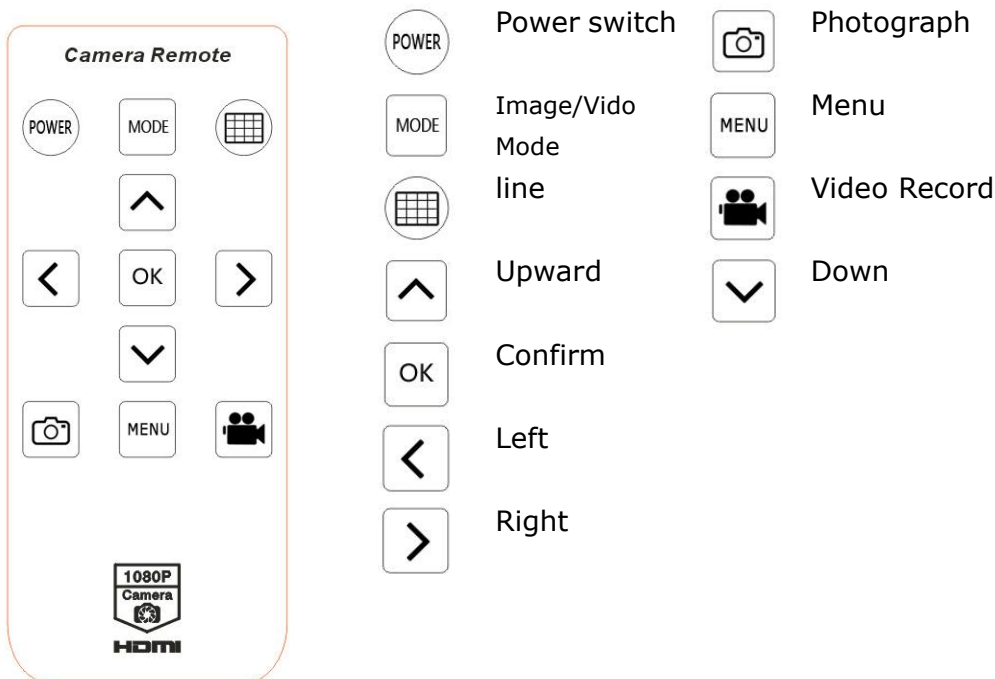

Safety Guides

- 1: When installing the equipment, please read the user manual carefully and follow the installation instruction, please kindly keep the manual for your reference. In order to provide our guest with a better customer experience, the product may have minor change during perfecting. the description in this instruction is only for reference, please take reference.
- 2: The camera power voltage is AC100V—240V@50-60Hz, please kindly make sure your power supply is in this range.
- 3: The standard power supply of the camera is 12V 1A, we recommend you use the power adapter which came together with the camera.
- 4: The camera should be stored between 0°C to 50°C, using with the humidity under 90%, prevent foreign object from entering the machine, do not spill liquid on the machine to prevent danger.
- 5: Prevent knock against and violent vibration, to prevent from water in the process of transportation, storage and install.
- 6: Do not attempt to disassemble the camera, there are no user serviceable parts inside.
- 7: When clear the camera's shell, please use dry soft cloth to wipe, if the dirt is serious, use a neutral detergent to wipe gently.
- 8: If there is a gray shadow on the image, use the dust blower to blow off the dust on the optical filter, do not use the detergent to wipe it.

Operation instruction

Preparatory work

- 1: Twist the cover and install the lens.

-
- 2: Inset the HDMI cable and DC power, when the LED light turn on yellow the camera is on.
 - 3: When connect the camera with the computer, just plug the USB line is OK (no need to use the power supply)

Menu operation instructions

1: line setting

Cross hair: click on the freeze/capture button to open or close the hair line.

Line: cycle from 1-10-OFF, click on the freeze/capture button to switch the numeric value

Direction: click on the freeze/capture button to switch horizontal/vertical/off

Position: click on the freeze/capture button to adjust, long press can rapidly increase/decrease, the numeric value smaller, the horizontal line more upper(if you choose vertical line then it will be more left), the numeric value larger then the horizontal line more lower(if you choose the vertical line then it will be more right)

Color: click on the freeze/capture button to switch and select the line color, there are transparency, black, white, red, green, blue and orange to be chosen.

Weight: click on the freeze/capture button to adjust the line weight.



Line Set	
Cross Hair	OFF
Line	1
Direction	OFF
Position	79
Color	WHITE
Weight	1

2: video resolution

Click on the ↑ or ↓ button to switch selection, click on OK to save your option.

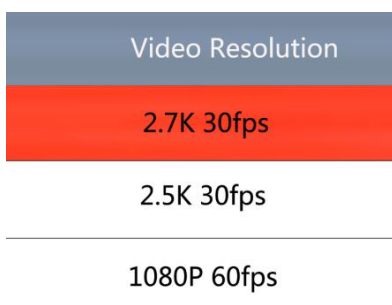

Video Resolution
2.7K 30fps
2.5K 30fps
1080P 60fps

3: image size

click on the ↑ or ↓ button to switch selection, click on OK to save your option.



4: picture scale

Click on the ↑ or ↓ button to select 16:9 or 4:3, click on OK to save your option.

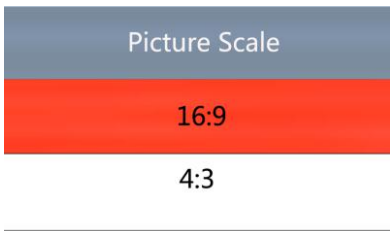

5: mirror contrast

Click on the ↑ or ↓ button to switch selection, click on OK to save your option.

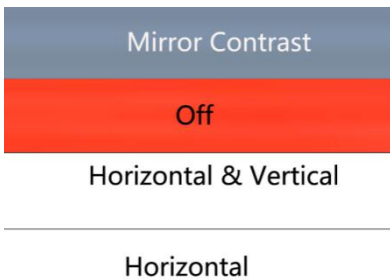

6: exposure

Click on the ↑ or ↓ button to switch selection, click on OK to save your option, the exposure value can be only adjusted under auto exposure.

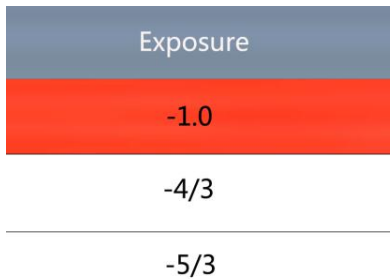
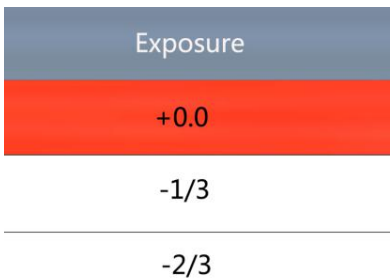

Exposure
+2.0
+5/3
+4/3

Exposure
+1.0
+2/3
+1/3

7: white balance

Click on the ↑ or ↓ button to switch selection, click on OK to save your option.

White Balance
Auto
Daylight
Cloudy

White Balance
Tungsten
Fluorescent

8: color

Click on the ↑ or ↓ button to switch selection, click on OK to save your option.

Color
Multicolor
Black & White
Sepia

Color
Inverse Color

9: language

Click on the ↑ or ↓ button to switch selection, click on OK to save your option.

Language
English
Francais
Espanol

Language
Portugues
Deutsch
Italiano



10: frequency

Click on the ↑ or ↓ button to select 50Hz or 60Hz, click on OK to save your option.

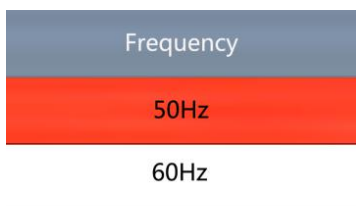

11: date/time

After finishing setting click on OK button to save and jumps to next setting, after finishing all setting click on OK button to save, then click on the MENU button to return back to main menu.

12: format

Choose cancel and click OK it will return to main menu, choose confirm and click OK it will be format.

All data will be deleted after format, make sure there is a copy when use this option.



13: default setting

Choose cancel and click on OK button it will return to main menu, choose OK and click on OK it will restore factory setting

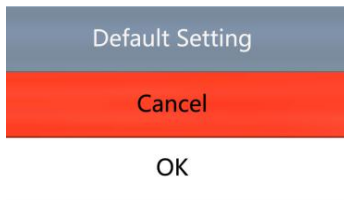

14: version

Model: HY-1139

15: Electronic amplification and reduction

Press the "freeze" button the image will electronic amplification, the multiple will be showed on the left of the image, the maximum multiple up to 5 times and image will be vague when magnification.

After electronic amplification, press on the "capture" button the image will reduction, the multiple will be shown on the left of the image and it can reduce to the original size

16: Switch photo and video mode

The system default is photo mode, press the "OK" button to take photo.

Press the "MODEL" button to switch video mode, press the "OK" button to start capture and press "OK" button again to stop recording.

HDMI output

First, make sure the connected monitor is hd monitor, otherwise the resolution can not reach 1080P.

Second, power on the microscope and connect it to the hd monitor, make sure there is power on when using since there is no built-in battery.

Third, turn on the microscope, put the observation on the platform and adjust the working distance to get a clear image.

Under the HDMI output, the microscope can take picture, but can not record video.

FAQ

1: Why these is no image on the monitor?

Check if all the lines connected properly and power switch is turn on.

2: Why the image vague?

Please adjust the focal distance, lighting angle, check if there is dirt on the lens.

3: Why the remote control can not work?

There is no battery in the package, check if you has installed it.

4: Why there is no image on monitor when playback?

Maybe the video is not kept intact, or the video file is too large, and the system needs run time.

5: Why isn't the photograph clear?

Please check whether the photo setting is the highest pixel.

6: Why it shows the TF card error?

First make sure it is a certified memory card, then format it and try again.

USB output S-EYE User Manual

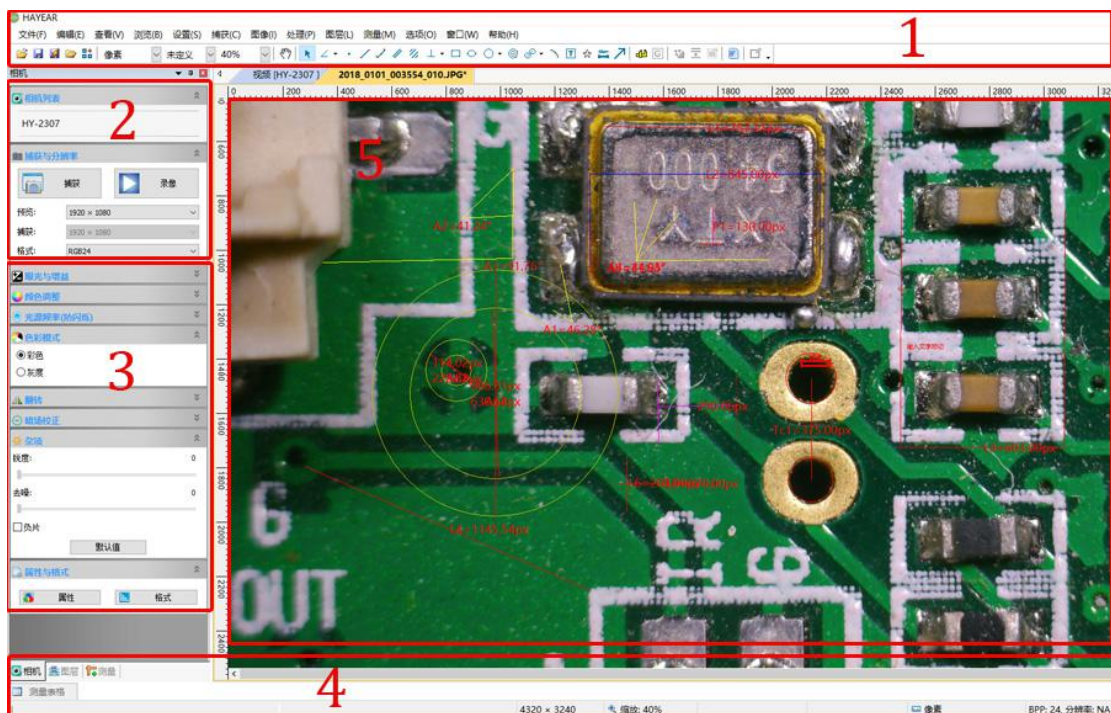

Overview

HAYEAR is an application for imaging a dynamic image processing , has the following characteristics:

User Interface

1. Toolbar: Take pictures/Recording video/Browse files.
2. Sidebar tab: Switching the rightmost control panels, currently provides camera control and measurement functions.
3. Control panel: Specific camera control and measurement operations.
4. Status bar: Display camera information, Change user interface view, Toggle measure result panel.
5. Main menu: Open setting dialog, show software information, etc.

Capture Images

You can capture pictures and videos:

1. Take a picture: Click "Snap" button to take a picture. Click the right arrow beside the "Snap" button to set picture file format and resolution.
2. Recording: Click "Record" button to start video recording, Click again to stop recording. When recording ,there will be an animation indicator over the image.
3. Browse: Click "Browse" button to open the folder where pictures and video stored.





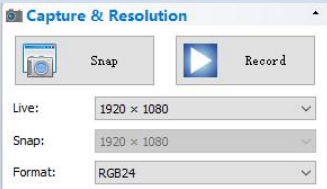
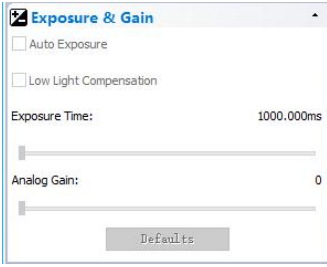
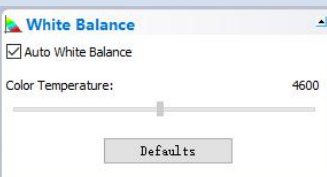

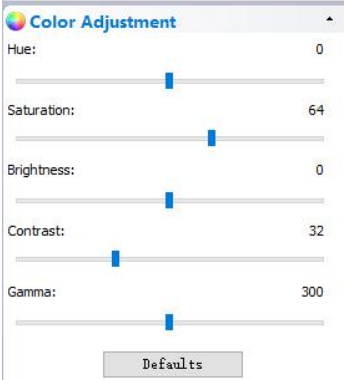
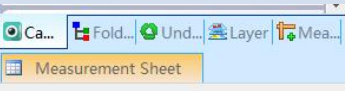









Camera Control

	<p>Device Control:</p> <ul style="list-style-type: none">● Support different cameras, preview resolution and output format.● The highest resolution is 1920x1080.
	<p>Exposure and Gain:</p> <p>If the connected camera can not support some functions such as brightness target value, then the corresponding parameter can not be set up</p>
	<p>White balance:</p> <p>If the connected camera can not support some functions such as brightness target value, then the corresponding parameter can not be set up</p> <p>Red, Green and Blue gain:</p> <p>If the connected camera can not support some functions such as brightness target value, then the corresponding parameter can not be set up</p>

	<p>Normal camera parameter adjustment.</p>
	<ul style="list-style-type: none"> ● Reset camera parameters. ● Open camera property dialog, generally supported by the DirectShow cameras

Measurement

Icon	Function	Description
	Move	Move or adjust the measurement tool.
	Point	Setup > Video Overlay > Marker
	Line	Measure length of a line.
	Vertical	
	Rectangle	Measure perimeter and acreage of a rectangle.
	Polygon	Measure perimeter and acreage of a polygon.
	Circle	Measure a circle, the circle is determined by center point and radius.
	Two Points Circle	Measure a circle, the circle is determined by two points.
	Three Points Circle	Measure a circle, the circle is determined by three points.
	Arc	Measure length of arc.
	Angle	Measure angle.
	Calibrate	
	Scale Bar	

	Text	Delete all measurement tools.
	Stitch	

Thanks

Thanks all of you for supporting our products. We hope you enjoy our products, and would be glad if they can even just slightly make your life better. If you have any question, or any advice and feedbacks, please feel free to contact us: info@hklrf.com .We'd like to provide the best service to you. Our official website is <http://www.HKLRF.com/>. We reserve all the right for the final explanation.